

MicAO

Adaptive Optic add-on
for SMLM

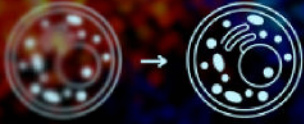

Increase resolution
by correcting aberrations

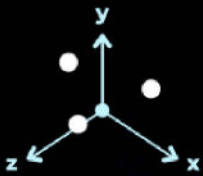

Shape your PSF
and go 3D



Image deeper
up to 50 μ m depth



Applications

Single Molecule Localization Microscopy (SMLM)

Use MicAO to increase resolution and go 3D in the following techniques :

- Photo Activated Localization Microscopy (PALM)
- STochastic Optical Reconstruction Microscopy (STORM)
- Single Particle Tracking (SPT)

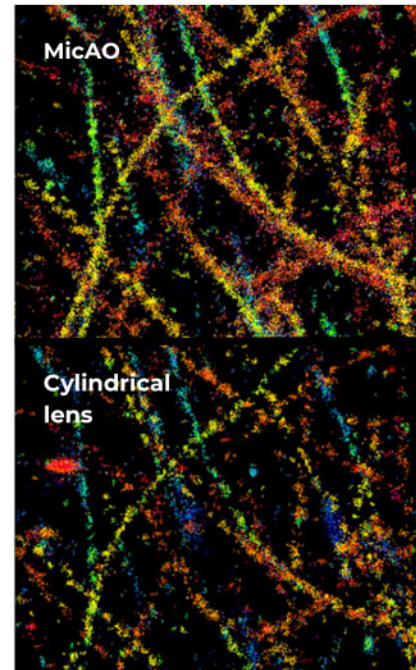
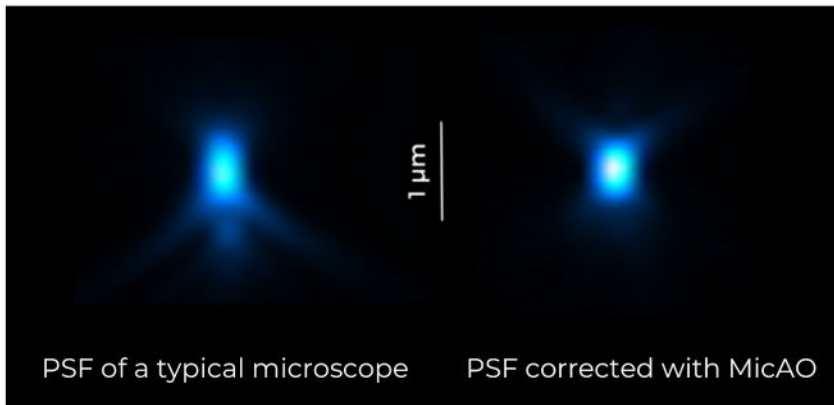

Features

- ✓ Restore Point Spread Function (PSF) symmetry thanks to deformable mirror inside MicAO
- ✓ Double the number of detected photons
- ✓ Reach near diffraction-limited resolution
- ✓ Visualize in 3D with the creation of a perfect PSF encoding astigmatism or tetrapod
- ✓ Obtain better 2D and 3D localization precision permitted by aberration correction
- ✓ Benefit from a stable PSF for more than 12 hours and day to-day results reproducibility
- ✓ Use with 60x or 100x objective lenses and with most imaging cameras

Boost your imaging performance :
Adaptive Optics
made
easy and efficient.

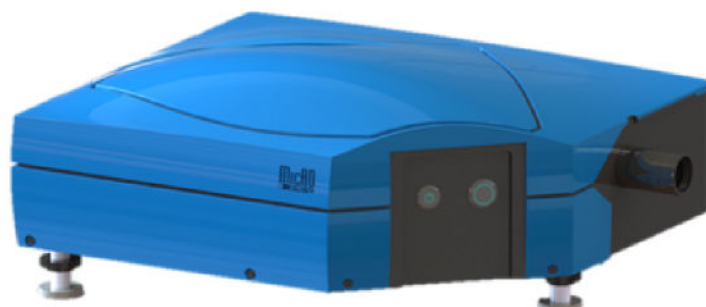

Specifications

Operating specs

Embedded deformable mirror	MirAO 52es
Optical transmission	95% at 525-675 nm
Operating wavelength range	500-700 nm (700-1100 nm for IR)
Wavefront temporal stability	< 10 nm RMS for minimum 12h

MISC

Objective compatibility	60x NA < 1.49 and 100x NA > 1.4
Microscope compatibility	Standard inverted-frames
Working environment	20-25°C, 20-80% RH
Dimensions	430 x 360 x 176 mm ³
Weight	9 kg
Power supply	10-220 V / 50-60 Hz

Operating system

Windows 10

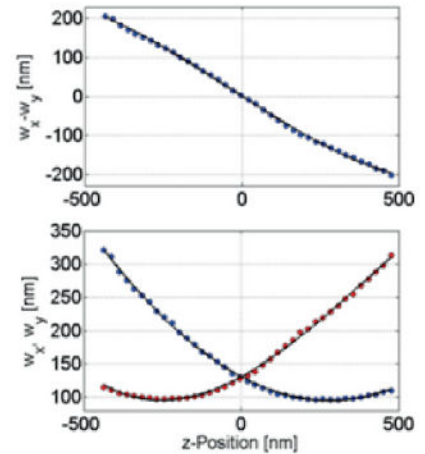

High lateral separation of astigmatic PSF along the whole Z range (up).
Calibration curve obtained using MicAO features aberration-free axial symmetry (down).

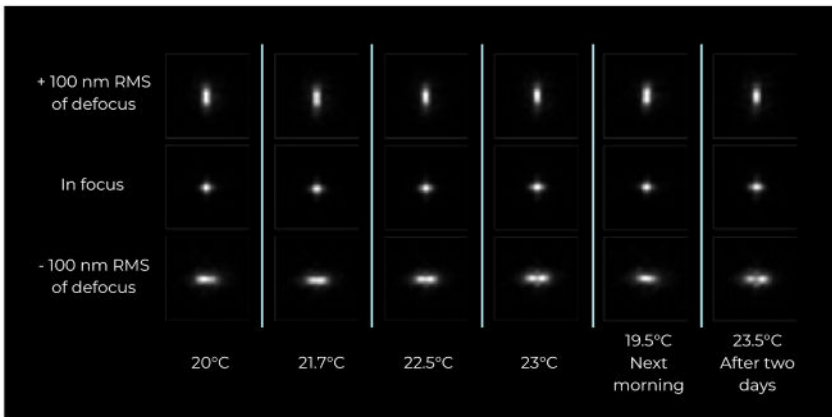

Example images of the diffraction-limited fluorescent bead at different ambient temperatures without stabilization module inside MicAO.
Middle row : the bead is in focus.
Upper and lower rows the bead is slightly out of focus.

Dimensions

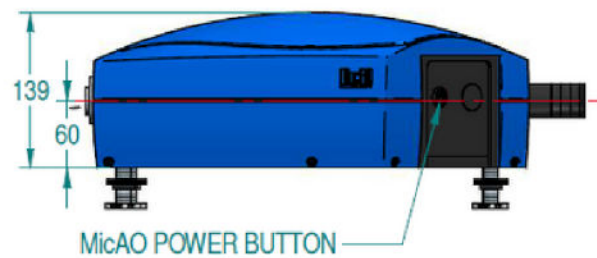
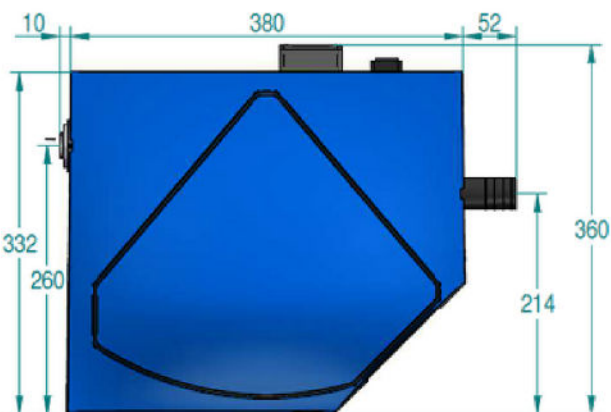

Available AO software

MICAO SOFT

The user-friendly MicAO software contains sensorless (image-based) aberration detection algorithms developed by the adaptive optics community.

The software can be operated standalone with its own user interface and is constantly being improved and updated.

Aberration detection methods and models allow MicAO users to perform single molecule imaging even deeper inside biological samples.

MicAO can correct for spherical aberration and restore the axial symmetry of the calibration curve in water-based biological samples up to depths reaching 50µm.

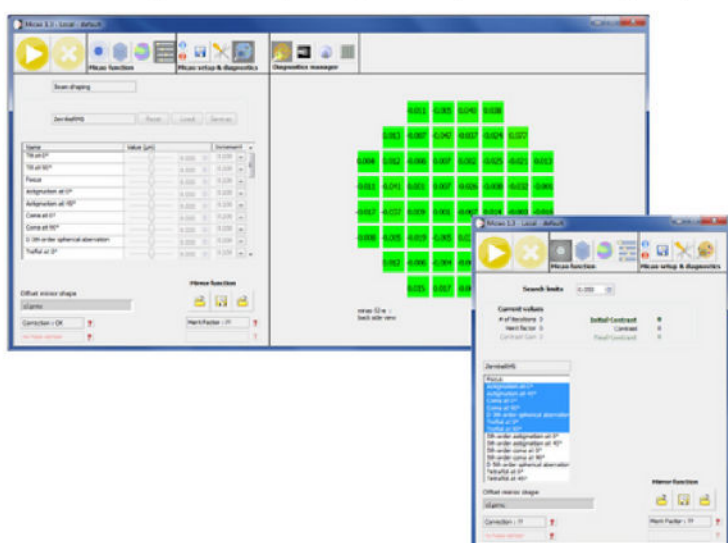

WAVEKIT BIO

WaveKit Bio is a Software Development Kit (SDK), available in C++ and Python, specifically designed for microscopy applications. In particular, it contains all the necessary functions to implement sensorless AO, using image-based iterative algorithms (e.g. 3N).

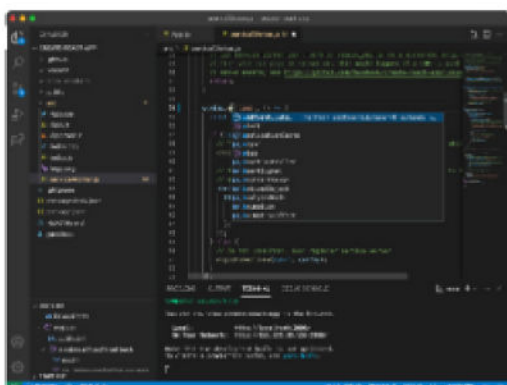

Contact

18, rue Charles de Gaulle
91400 ORSAY - France

Phone :

+33 (0)1 64 86 15 60

E-mail :

sales@imagine-optic.com

Follow

[LinkedIn : mu Imagine](#)

[Twitter : @mu_imagine](#)



Adaptive Optics
adapted to microscopy

a division of [imagine\[**o**\]ptic](#)