

## i-SPEED SERIES



## i-SPEED® 5 SERIES

The perfect balance  
of speed, size,  
and memory.



# A NEW PARADIGM IN HIGH-SPEED CAMERAS

2.1 MEGAPIXEL CMOS SENSOR

1 MILLION FPS MAX SPEED

13 GPIXELS

1920 x 1080 @ 6,300 FPS

ISO 16,000 / 125,000

SHUTTER TIME: STANDARD 1  $\mu$ S,  
FAST MODE TO 277 NS\*

DIRECT CONNECT REAR PANEL

HEALTH MONITOR SYSTEM

i-CHEQ STATUS MONITORING

UP TO 2TB EXTERNAL SSD

UP TO 8TB INTERNAL SSD

COMPACT SIZE BODY DESIGN

HANDHELD CONTROL DISPLAY UNIT

MODEL UPGRADE PROGRAM

MADE IN THE UK AND USA



\*Export restricted

# AST CMOS ultra-high speed sensor

The heart of a high-speed camera is the sensor. i-SPEED® cameras are no different. Employing our newest Advanced Sensor Technology (AST), the sensors in our i-SPEED 5 Series and our new i-SPEED 7 models are the most advanced and highest performing in the iX Cameras product line.

iX Cameras designs and develops its own state-of-the-art proprietary sensors. This commitment to excellence and quality control keeps us ahead of the commercial sensors found in most high-speed cameras. In 2018, we launched our AST initiative.

These new sensors boast increased light sensitivity, enhanced image clarity, ultra-high resolution at high speeds, and proprietary black level control for deeper blacks and low noise.

We even optimized the 13.5 μm pixel size for the proper balance between high-resolution (for image clarity) and exceptional light sensitivity normally found only with larger pixels.

## Spectral response curves

Our latest custom designed CMOS sensor with class-leading light sensitivity provides high quality images for accurate analysis.

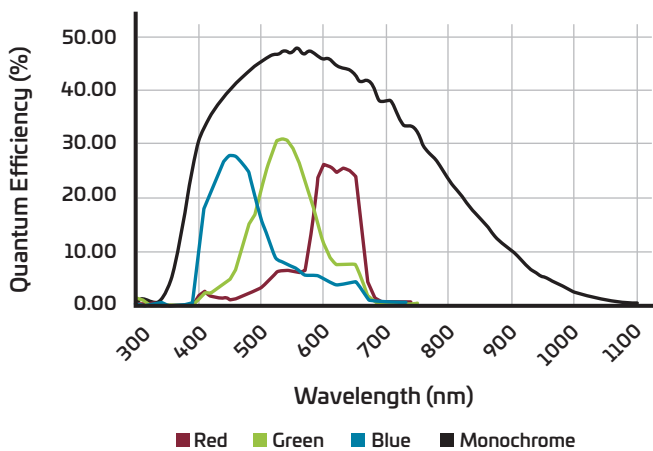

## Unparalleled throughput

The i-SPEED® 5 Series (508, 510, and 513) offers image throughput speeds of up to 13 GPixels/second (13 billion pixels processed every second), with a maximum frame rate of 1 million frames per second. An ideal balance of resolution and frame rate for greater accuracy of motion analysis.

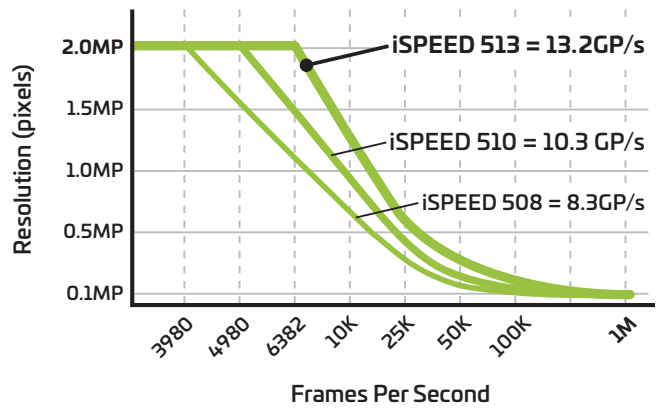

## Sensor highlights

- 2.1 Megapixel CMOS Sensor
- Optimized full well capacity
- Full 12 bit dynamic range
- Dynamic pixel control
- New sensor drive engine
- 13 GPixels/s throughput
- Exceptional light sensitivity
- 13.5 μm pixel size



# Features that redefine high-speed performance

## Innovative internal cooling system

The i-SPEED® 5 cameras are robust and resistant to environmental challenges due to their cooling system that extracts heat from the sensor and electronics without airflow. This unique technology ensures that the internal electronics are completely environmentally sealed—making the camera resistant to ingress of dust, carbon fiber and corrosive particles.

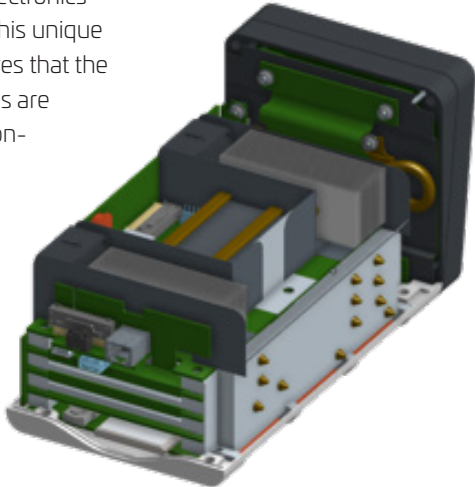

## Compact size

The i-SPEED 5 has a small footprint and volume—perfect for integration into other products such as flight follower systems, and ideal for experiments in the lab or field or locations where other high-speed cameras may be too heavy or bulky.



## 8TB internal SSD storage

Recording at high speeds with high resolutions produces a great deal of data. The i-SPEED 5 Series camera can be configured with up to 8TB of internal SSD storage. You can quickly and seamlessly transfer data from the camera's internal RAM memory to secure, non-volatile SSD—without touching the camera—for subsequent analysis. A 2TB capacity allows the user to store multiple recordings and conduct tests in quick succession.

## Don't stop—just swap

Swappable SSD technology allows you to transfer high resolution images between a camera and a computer. The external solid state drive (xSSD) memory cartridge, available in 250GB, 500GB, 1TB, and 2TB sizes, is ideal for secure non-volatile storage of large video files without interrupting the video capture process.



## Upgrade path between three models

The i-SPEED 5 Series has been designed to allow for easy upgrades between models as performance or application requirements increase. Add additional memory and options such as xSSD or upgrade to a higher performance model.

## Premium motion analysis software included

Turn your i-SPEED camera into a precision measurement device with ProAnalyst, premium video analysis software from Xcitex Inc. Analyze, graph and output speed, acceleration, and angular motion. Measure fluid dynamics, PIV, displacement, and more with optional toolkits.

*ProAnalyst*  
by Xcitex

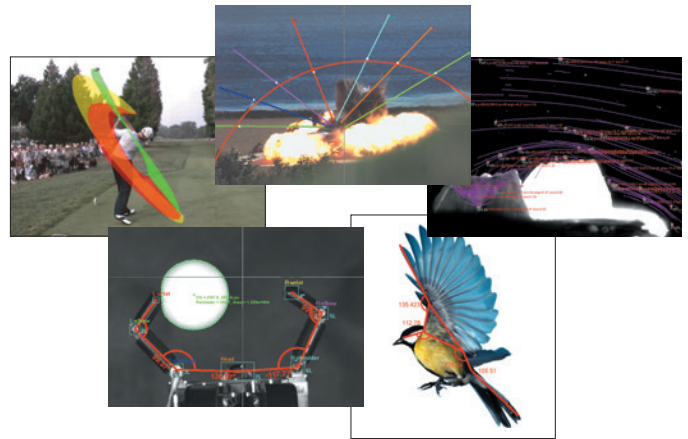

## i-CHEQ status monitoring

Monitor your camera's status at a glance and in real-time with i-CHEQ 360. View in-camera details for single or multiple camera setups with Remote i-CHEQ, part of the i-SPEED® Software Suite 2.0. Understand your camera's exact status using the three variable color lights on the front of the camera and mirrored inside the control software.



## On board image processing

The i-SPEED 5 does not output unprocessed RAW files by default. All video and images generated by the camera are fully processed by the camera itself. View the videos right out of the camera, with no post-processing necessary after the video is uploaded—simply open your images and video in any movie player. You have the option to save in AVI, TIFF, JPEG, RAW and IXV.

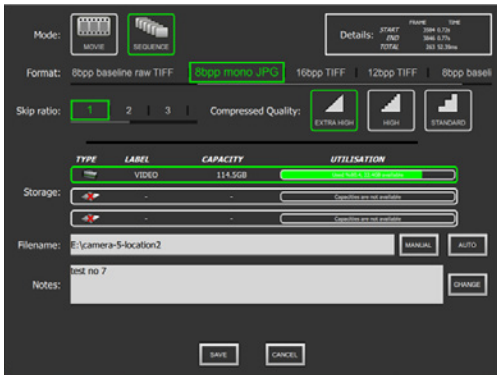

## Camera Layouts



Layouts are arrangements of cameras that are used together for a test. Multiple layouts can be defined and saved. For each layout, an actual photo of the test can be selected, or an artificial image can be generated. Cameras can be added to a layout and dragged to specific locations in the background image.

Layouts are arrangements of cameras that are used together for a test. Multiple layouts can be defined and saved. For each layout, an actual photo of the test can be selected, or an artificial image can be generated. Cameras can be added to a layout and dragged to specific locations in the background image.

## Real-time health monitor

Observe the camera's internal condition and external environment. Switch off fans (Quiet Mode) to prevent vibration in microscopic applications. View voltage information, fan speed and camera temperature.

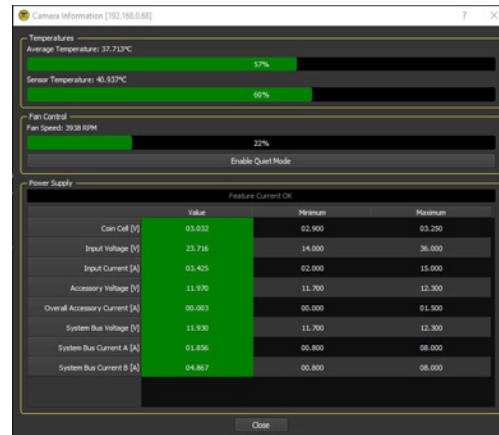

## Direct Connect rear panel

The newly designed rear panel of the i-SPEED 5 Series added more BNC connections to reduce the requirement for a feature lead. Now the Trigger, Sync In/Out and Exposure Out are on the rear panel.

- 1 Power button 14-36V
- 2 HD-SDI
- 3 Power input
- 4 Ethernet
- 5 HDMI
- 6 USB
- 7 I/O - 12V output
- 8 I/O - Remote power
- 9 I/O - I-IRIG
- 10 I/O - Trigger
- 11 I/O - GPIO 0
- 12 I/O - GPIO 1
- 13 I/O - GPIO 2
- 14 Future expansion
- 15 Trigger In
- 16 Sync in/out
- 17 Exposure out

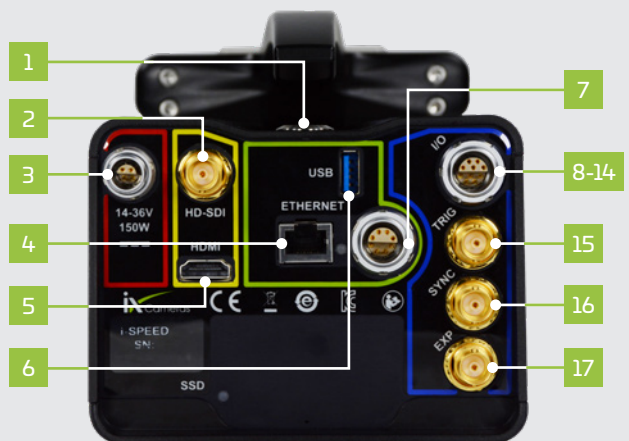

# iX Cameras CDUe for complete camera control without a PC

The industry unique CDUe (Control Display Unit) makes operating the camera quick, intuitive, and portable. The CDUe allows you to frame your field of view, set resolution, frame rate and shutter speed, record, and review with the touch of a finger. With the CDUe, take your system to the field without the need of a laptop.

## One step camera connection

Your CDUe has i-SPEED Control software pre-installed. Once you connect the CDUe to the camera with an Ethernet cable and USB adapter, operating the camera is as simple as launching the application on the CDUe. Just connect and control the camera.

## Software designed to maximize your workflow

The custom CDUe Control software allows users to control camera settings to meet all their applications needs. The touch screen functionality of the CDUe provides an intuitive, user-friendly experience.

All the commands to control the camera are conveniently located at the bottom of the screen, allowing the user to select frame and shutter speeds and resolution and then continue on to record, review, and save. The top of the screen displays the camera and CDUe status—all the key information you need to conduct your experiments.



## Capturing video and triggering



### Speed

Touch the Speed button to set the desired frame rate.



### Shutter

Touch the Shutter button and set the shutter to the desired value. The shutter can be set with the user's choice of time measurement. The default setting is X, and this is always relative to the frame rate. The shutter can also be set to  $\mu$ s as a finite defined time or 1/x for values that are more familiar to photographers.



### Assist

The Assist function of the CDUe, unique to i-SPEED cameras, provides our customers with a one-touch feature to ensure the subject they are studying is in focus, and the setting is set to the right exposure and has the correct amount of light to get the best video.



### i-FOCUS

This is a colored overlay that peaks to red when an item is sharp and therefore in focus. This makes setting the focus very easy in bright light environments or on moving machinery.

Another advantage of the i-FOCUS feature is that the depth of field can be seen, and therefore focus can be balanced to suit any movement in the scene.



### i-EXPOSE

The i-EXPOSE feature highlights peak white areas of the image in red and highlights peak black areas of the image in blue. This allows the user to balance the image between peak white and peak black and also ensure that important parts of the image are not too saturated or lost in darkness.



### Low Light

Resolution may be reduced when operating at high frame rates, so the camera needs to be set up and aligned for reduced resolution. This may be difficult to achieve in low light level situations. The Low Light feature allows the user to quickly set the frame rate to 60 fps while maintaining the set resolution to allow for alignment and focusing of the camera.

# Advanced IRIG system

IRIG is a common method to distribute an accurate time signal. However, the advancement of camera performance has made IRIG accuracy difficult to achieve.

Every analog signal has noise—this affects the on-time position.

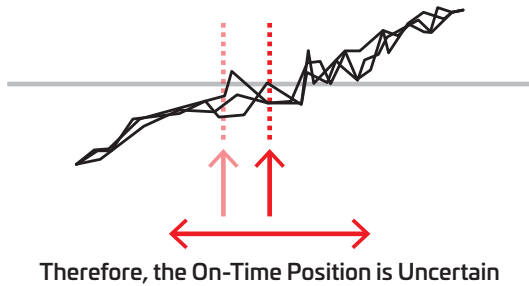

Some IRIG generators produce a jittery signal—digital sampling adds to this. Therefore, the on-time position is uncertain.

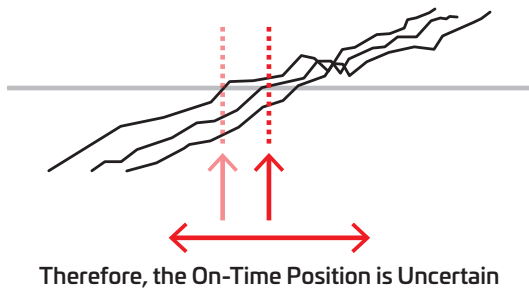

Generator and camera timings can be inaccurate relative to each other depending on factors such as temperature, age and manufacturers' tolerance.

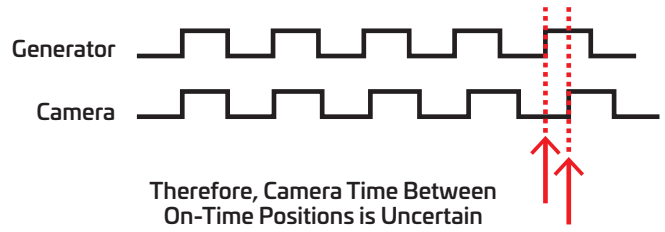

The common approach used by most high-speed camera manufacturers is that the camera timing is allowed to drift and only re-set at each on-time position. Therefore, at the end of each one-second time period there could be a substantial error. This is compounded if the IRIG signal is lost and the signal drifts.

### Most Common Approach

- Camera timing allowed to drift
- Only reset at each on-time position

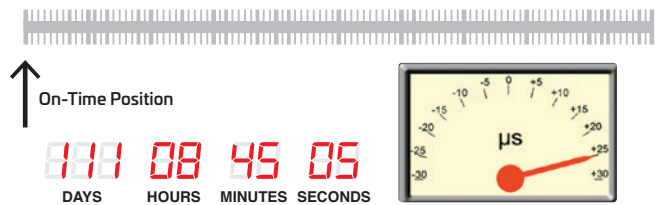

At the End of Every Second, There Can be a Substantial Error

## The new i-SPEED IRIG system is designed to reduce errors between on-time positions and minimize the drift on loss of signal.

- The system incorporates a Digital Phase Locked Loop (DPLL) that is not affected by analog signal noise and generator jitter.
- The i-SPEED® 5 Series cameras also include an internal shadow clock which adjusts automatically to match the IRIG generator, eliminating drift and jitter.

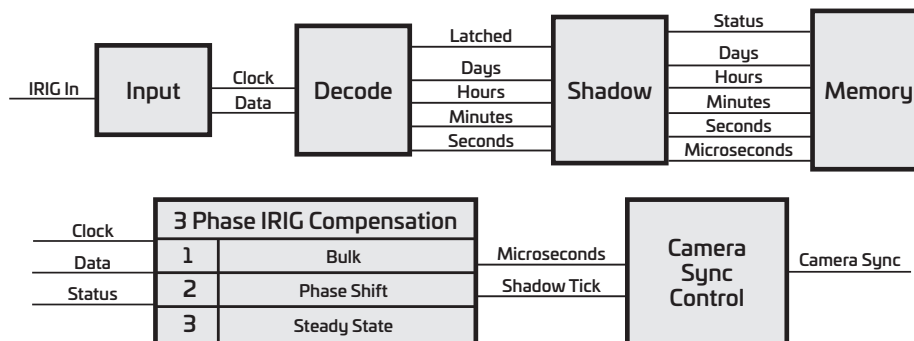

# Performance

## Upgrade path between three models

The i-SPEED® 5 Series has been designed to allow for easy upgrades between models as performance or application requirements increase. Add additional memory and options such as xSSD or upgrade to a higher performance model.

### *i-SPEED® 513*

Frame Speed	Resolution	18GB	36GB	72GB	96GB	144GB
100	1920x1080	60.83	121.70	243.44	324.60	486.92
200	1920x1080	30.41	60.85	121.72	162.30	243.46
300	1920x1080	20.28	40.57	81.14	108.20	162.30
500	1920x1080	12.17	24.34	48.68	64.92	97.38
1,000	1920x1080	6.08	12.17	24.34	32.46	48.69
2,000	1920x1080	3.04	6.09	12.17	16.23	24.34
3,000	1920x1080	2.03	4.06	8.11	10.82	16.23
3,985	1920x1080	1.53	3.05	6.11	8.14	12.21
4,980	1920x1080	1.22	2.44	4.89	6.51	9.77
5,000	1920x1080	1.22	2.43	4.87	6.49	9.74
6,382	1920x1080	0.95	1.91	3.81	5.08	7.62
7,500	1792x996	0.96	1.92	3.84	5.13	7.69
10,000	1512x852	0.99	1.95	4.00	5.33	8.00
15,000	1232x696	1.00	2.00	4.01	5.34	8.01
20,000	1064x600	1.00	2.02	4.03	5.38	8.07
50,000	672x366	1.10	2.09	4.19	5.58	8.38
100,000	504x228	1.12	2.24	4.48	5.97	8.96
200,000	504x96	1.33	2.66	5.32	7.09	10.64
300,000	504x60	1.42	2.84	5.68	7.57	11.36
500,000	560x24	1.92	3.83	7.66	10.22	15.33
750,000	504x12	2.84	5.67	11.36	15.14	22.72
1,000,000	112x48	4.79	9.58	19.16	25.55	38.32

### *i-SPEED® 510*

Frame Speed	Resolution	18GB	36GB	72GB	96GB	144GB
100	1920x1080	60.83	121.70	243.40	324.60	486.92
200	1920x1080	30.41	60.85	121.70	162.30	243.46
300	1920x1080	20.27	40.57	81.14	108.20	162.30
500	1920x1080	12.17	24.34	48.68	64.92	97.38
1,000	1920x1080	6.08	12.17	24.34	32.46	48.69
2,000	1920x1080	3.04	6.09	12.17	16.23	24.34
3,000	1920x1080	2.03	4.06	8.11	10.82	16.23
3,985	1920x1080	1.53	3.05	6.10	8.13	12.20
4,980	1920x1080	1.22	2.44	4.89	6.51	9.77
5,000	1904x1074	1.26	2.52	5.04	6.72	10.08
6,382	1512x1080	1.24	2.47	4.94	6.59	9.88
7,500	1368x882	1.24	2.54	4.96	6.62	9.94
10,000	1344x756	1.26	2.53	5.07	6.76	10.14
15,000	1120x606	1.26	2.53	5.06	6.75	10.12
20,000	952x528	1.28	2.56	5.12	6.83	10.25
50,000	560x318	1.44	2.89	5.78	7.71	11.57
100,000	392x216	1.52	3.04	6.08	8.46	12.17
200,000	392x96	1.71	3.42	6.84	9.13	13.69
300,000	392x54	2.03	4.05	8.11	10.82	16.23
500,000	392x24	2.74	5.47	10.95	14.60	21.91
750,000	112x60	5.11	10.22	20.44	27.25	40.88
1,000,000	112x36	6.39	12.78	25.56	34.08	51.12

### *i-SPEED® 508*

Frame Speed	Resolution	18GB	36GB	72GB	96GB	144GB
100	1920x1080	60.83	121.70	243.44	324.60	486.92
200	1920x1080	30.42	60.85	121.72	162.30	243.46
300	1920x1080	20.28	40.56	81.15	108.20	162.30
500	1920x1080	12.17	24.34	48.68	64.92	97.38
1,000	1920x1080	6.83	12.17	24.34	32.46	48.69
2,000	1920x1080	3.04	6.09	12.18	16.23	24.35
3,000	1920x1080	2.03	4.05	8.11	10.82	16.23
3,985	1920x1080	1.53	3.05	6.10	8.13	12.20
4,980	1512x1080	1.58	3.17	6.33	8.45	12.67
5,000	1736x960	1.58	3.10	6.18	8.25	12.36
6,382	1344x966	1.55	3.11	6.22	8.29	12.44
7,500	1400x786	1.56	3.12	6.24	8.33	12.48
10,000	1232x666	1.57	3.13	6.28	8.38	12.56
15,000	1008x534	1.59	3.25	6.38	8.51	12.76
20,000	840x474	1.62	3.24	6.47	8.63	12.94
50,000	504x282	1.81	3.63	7.25	9.67	14.50
100,000	336x192	1.99	3.99	7.98	10.65	15.97
200,000	336x84	2.28	4.56	9.13	12.17	18.26
300,000	336x48	2.66	5.32	10.65	14.20	21.30
500,000	392x18	3.65	7.30	14.60	19.47	29.21
750,000	112x42	7.30	14.60	29.20	38.93	58.40
1,000,000	112x30	7.67	15.34	30.68	40.91	61.36

Frame rates, resolution, and duration (in seconds).  
Note: Other resolutions and speeds are available



# Specifications

## IMAGER

Sensor type	Custom CMOS
Sensor resolution	1920 x 1080 pixel
Sensor size	25.920 mm x 14.580 mm
Sensor diagonal	29.74 mm
Pixel size	13.5 $\mu$ m
Bit depth	12 bit (36 bit color)
Light sensitivity Mono (Gain off/on)	16,000 / 125,000
Light sensitivity Color (Gain off/on)	4,000 / 32,000
Maximum frame rate	1,000,000 fps
Shutter type	Global exposure
Shutter time, standard	1 $\mu$ s min (standard)
Shutter time, fast mode	277 ns* min

## SYNCHRONIZATION and CAPTURE

Trigger	TTL T0 to 0-100%
Trigger modes	Circular, ROC, BROCC
Sync	10 Hz – 350 kHz
Luminance histogram	Iris setting aid tool
i-CHEQ 360	Camera status LEDs
i-FOCUS	Focusing aid tool
i-EXPOSE	High/low exposure highlight
Control	PC or CDUe
IRIG input	IRIG – B to 1 $\mu$ s
Internal memory	18 GB standard, upgrade to 144 GB

## CONNECTIVITY

Video outputs	HD-SDI, HDMI
USB	USB 3
Network	1 Gb RJ45 / 10 pin Lemo
Video	IXV, AVI (compressed or uncompressed)
Image sequence	TIFF, JPG, RAW
Ethernet control	1 Gb
Remote control	Via supplied software

## PC SOFTWARE

Standard control	Control ONE
Premium control	Control MULTI-DAQ
Editing	i-SPEED Movie Maker
Analysis	ProAnalyst® by Xcitex
Viewer	i-SPEED Viewer
Software Developers Kit	C++
Synchronized data acquisition	USB DAQ, 8 options
Language	Local language (available in certain countries)

## PHYSICAL and ENVIRONMENTAL

Dimensions inches	5.0 (W) x 5.1 (H) x 12.0 (L)
Dimensions mm	127 (W) x 129 (H) x 305 (L)
Weight	9.9 lb (4.5 kg)
Input voltage	14-36 V
Power consumption	110 W nominal, 150 W max
Mounting	1/4 x 20 and 3/8 x 16 tripod plate
Lens mount	Custom, swappable lens plate
EMC	EN55032-A, EN55024
Safety	BS EN61010-1 (camera), IEC60950 (PSU)
CE marking	EMC directive (camera), EMC directive, LV directive (PSU)
Lead free	RoHS directive
WEEE	Compliant
Temperature °F	14° to 122° operation, -4° to 140° storage
Temperature °C	-10° to +50° operation, -20° to 60° storage
Pressure	71 kpa to 106 kpa
Relative humidity	95% at 104°F non-condensing
Power input connector	4 pin Lemo
Trigger input	BNC 75 $\Omega$
I/O connector	10 pin Lemo, trigger in / sync / exposure out / remote power

## PURCHASING OPTIONS

CDUe	Controller Display Unit
Sensor	Color / Mono
Memory	18 GB (std) / 36 GB / 72 GB / 96 GB / 144GB
Shutter time	1 $\mu$ s (std) / 277 ns*
Internal SSD	500 GB / 1 TB / 2 TB / 4 TB / 8 TB
External SSD	500 GB / 1 TB / 2 TB
Lens mounts	F mount (Nikkor D) / F mount (Nikkor G) C mount / EF mount
Warranty	1 yr (std) / 2 yr / 3 yr
IRIG	IRIG-B

\*Export restricted.

<sup>†</sup>Cameras must be turned on above 0°C / 32°F and can operate down to -10°C / -14°F.

Our cameras  
set us ahead.  
Our software  
sets us apart.



The i-SPEED® Software Suite 2.0 enables you to use the software with a Windows laptop, desktop, or the optional Controller Display Unit (CDU). With both versions of the PC software—Standard and Premium—you will experience unparalleled features and the most complete set of functions with a modern and intuitive GUI. Control your camera via Gigabit Ethernet connection—load and control single and multiple camera configurations or connect remotely for uninterrupted access to restricted areas.

### Two levels to suit your specific application requirements

- Control ONE: Control a single camera from a laptop or PC; includes ProAnalyst® Introductory Edition
- Control Multi-DAQ: Control multiple cameras and/or synchronize with data acquisition devices; includes ProAnalyst® Lite Edition

### Local Languages

To accommodate our worldwide customer base, the i-SPEED Software Suite 2.0 will be available in local languages to meet the needs of our global customers.

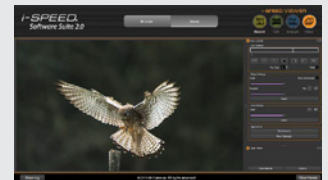
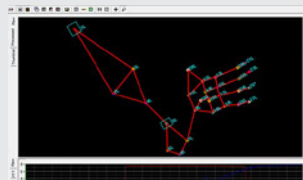

#### Record

Customized connection and crow's-nest layout window

- Instantly sync and record from multiple cameras.
- Choose multiple configurations of a single camera, or quickly configure a new camera and new capture settings from inside the simplified connection control panel.

#### Edit

Renderless editing suite—i-SPEED Movie Maker features virtually no render lag

- The world's only editing software designed specifically for high-speed video
- Focuses on frame rate and video speed

#### Analyze

Your i-SPEED camera becomes a precision measurement device with ProAnalyst® from Xcitex Inc., the world's most advanced motion analysis software

- Analyze, graph, and output speed, acceleration, fluid dynamics, PIV, and more with optional toolkits.

#### Share

Play just about anything

- View and import saved files directly from the camera.
- Align and play multiple file types.
- Load and control the video and playback speed all without load times—load and play multi-gigabyte files instantly.

### Software Developer's Kit (SDK)

iX Cameras will provide the SDK kit and the technical support to customize the software to meet your specific applications needs. We will work with you to integrate program commands into your own software to allow you full control of all i-SPEED 5 camera functions and features.

# i-SPEED Software Suite 2.0

	Standard Bundle	Premium Bundle
<b>Bundled Software</b>		
Control ONE	■	
Control Multi-DAQ		■
Viewer	■	■
Movie Maker		■
ProAnalyst® by Xcitex Motion Analysis Software (see next page for details)	Introductory	Lite
<b>Main Functions</b>		
Language	Local Languages	Local Languages
Simple Mode	■	■
Customizable Workspaces	■	■
Check for Updates	■	■
<b>Camera Connect</b>		
Single Camera Control	■	■
Multi-Camera Control		■
Sync DAQ Control		■
Camera Naming / Positioning / Appearance	■	■
Crow's Nest Test Set-Up View	■	■
Real-Time Camera Health Monitoring System	■	■
<b>Camera Capture</b>		
i-FOCUS	■	■
i-EXPOSE	■	■
Low Light Mode	■	■
Luminance Histogram (Full Image or ROI)	■	■
Calibration Snapshot for DIC / PIV	■	■
Session Reference / Auto-Black Reference	■	■
Remote Session Reference / Auto-Black reference (with Mechanical Shutter)	■	■
DIC Tools	■	■
Multiple Buffers	■	■
Rearm	■	■
Auto Save		■
Buffer Advance Mode	Auto Advance, Auto Advance and Record	Auto Advance, Auto Advance and Record
Sync Modes	Normal	Normal, Random Snapshot
Sync	Master / Slave	Master / Slave
Trigger Modes	Normal (Circular)	Normal (Circular), ROC, BROCC
Video Trigger (i-SPEED 7 models only)	NA	NA
Software Trigger	■	■
TTL Trigger	■	■
IRIG Phase Lock (sold separately)	Optional	Optional
i-CHEQ	■	■
Synchronized Integrated Lighting Control* (i-SPEED 7 models only)	NA	NA
On-Board PIV Double Pulse Timing for Driving PIV Laser Systems		
Dual Brightness Twin Recording		
<b>Video Review</b>		
Time Zoom	■	■
Bookmarks	■	■
Measure Window (Angles, Distances)	■	■
Video Processing	■	■
<b>Measure (see next page for details)</b>		
Linear, Distance, and Velocity	■	■
Angular, Angle, and Angular Velocity	■	■
<b>Save</b>		
File Formats	TIFF, JPG, RAW, IXV, AVI	TIFF, JPG, RAW, IXV, AVI
File Name Sequencing for Ingestion Into 3rd Party Software	■	■

\*Patent pending

# ProAnalyst® Motion Analysis Software by Xcitex

ProAnalyst	Introductory	Lite
<b>File Management</b>		
AVI, WMF, ASF, CINE, MPED-1, MOV, and MP4 Files	■	■
BMP, JPG, PNG, TIFF Image Sequence Compatibility	■	■
Project-Based File Management	■	■
Video Explorer	■	■
Pack / Unpack Projects	■	■
<b>Image Calibration and Processing</b>		
Image Processing	■	■
Image Filtering		Limited
Video Timeline	■	■
Layered Display and Editing	■	■
2-D Scene Calibration	■	■
Perspective and Multi-Plane Scene Calibration		■
<b>Video Analysis</b>		
2-D Feature Tracking	■	■
Number of Auto-Track Features	1	256
Number of Manual Track Points	32	256
Real-Time Annotations of Distance and Angle Between Features		■
<b>Graphing and Computation</b>		
Graphing Within ProAnalyst		Limited
<b>Notes and Reports</b>		
External Data Import		■
Tracking Data Export to C3D, Diadem, Excel, MATLAB	Limited	■
Video Frame, Data Point, and Global Notes		■
Image Annotation	■	■

ProAnalyst Professional and 3-D Professional	Professional	3-D Professional
<b>Image Calibration and Processing</b>		
3-D Manager		■
3-D Scene Calibration		■
Lens Distortion Correction	■	■
<b>Video Analysis</b>		
Image Stabilization Toolkit*	Optional	Optional
Particle Counting, Sizing, and Tracking Toolkit*	Optional	Optional
Contour / Edge Analysis Toolkit*	Optional	Optional
Particle Image Velocimetry Toolkit	Optional	Optional
Impact Excursion Toolkit	Optional	Optional
Biological Cell Tracking Toolkit	Optional	Optional
1-D Line Tracking	■	■
3-D Measurement and Analysis		■
<b>Graphing and Computation</b>		
One-Click FFT	■	■
2-Axis Graphing	■	■
3-Axis Graphing	■	■
3-D Graphing of Trajectories from 3-D Manager	■	
Data Filtering	■	■
<b>Notes and Reports</b>		
HTML, PowerPoint, and Print-Ready Report Generator	■	■

\*Included in Professional Ultimate Bundle

## Upgrade Options

- From **Introductory** to **Professional Edition**
- From **Introductory** to **Professional Ultimate Bundle**
- From **Lite** to **Professional Edition**
- From **Lite** to **Professional Ultimate Bundle**
- From **Professional** to **3-D Professional Edition**
- From **Professional Ultimate Bundle** to **3-D Professional Ultimate Bundle**

# iX Cameras shares its CAD models

With many applications, the camera is a component in the overall solution. While commercially available accessories can fulfill most requirements, there are always some situations that require a bit extra. This may be as simple as a bracket to mount an accessory to the camera, or as complex as a full OEM system integration. Whatever the requirement, accurate and complete interface data is a must. As such, iX Cameras is pleased to provide another first in our industry by opening access to the CAD model data for the exterior of our cameras.

For more information, please visit our [Cameras CAD Models](#) page.

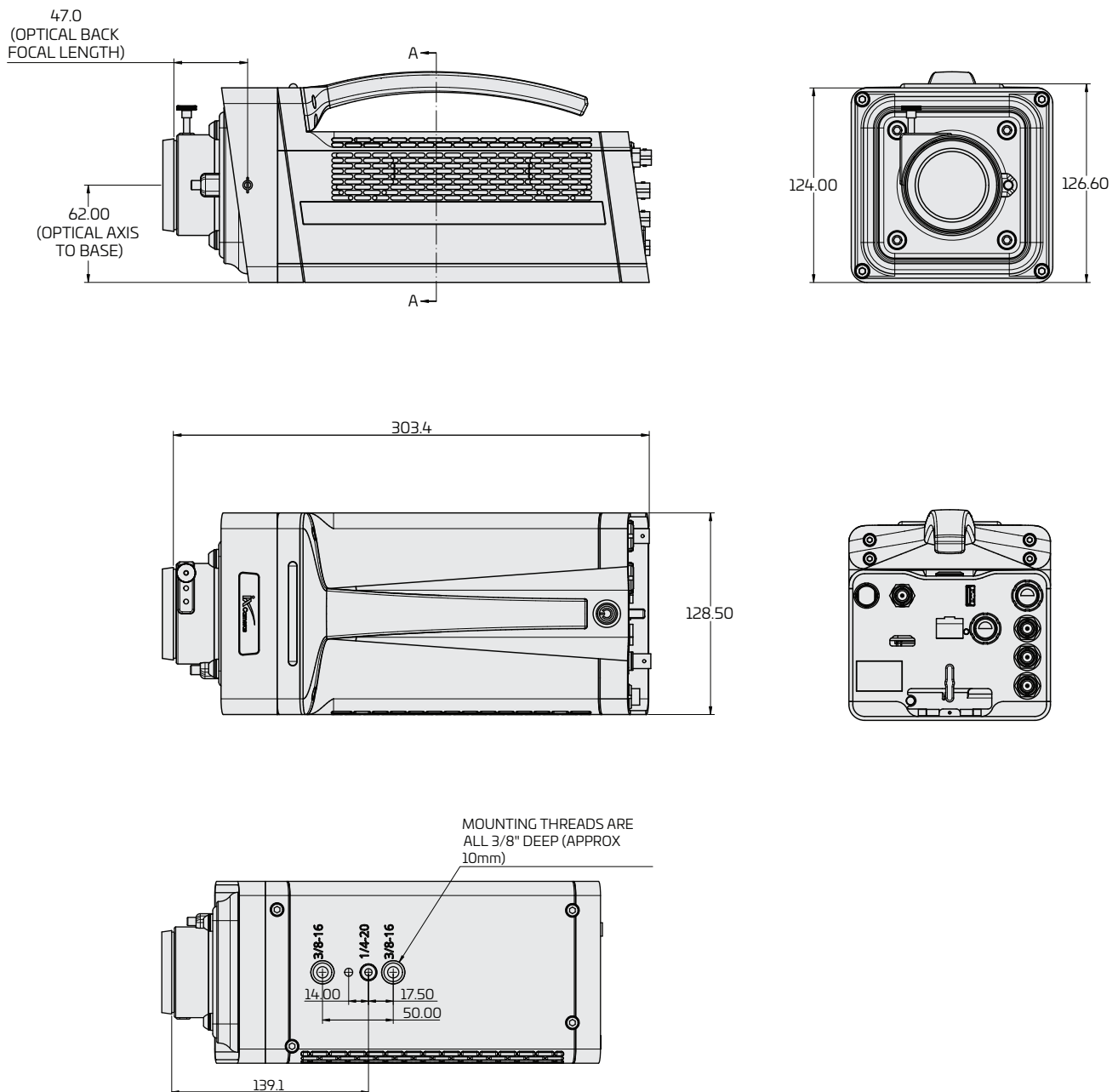

# Advanced high-speed cameras for any application

The new i-SPEED® 5 Series with the AST sensor offers our customers three models (508, 510, 513) of high-speed cameras to use in the lab, field, or test range recording a wide range of applications without compromising high resolution at high recording speeds—capturing the fastest events while reducing motion blur.

## Fluid Dynamics

The combination of high resolution and superb light sensitivity allows for capture of fluid flows with zero motion blur.

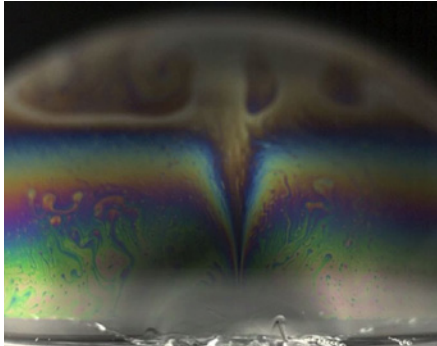

Courtesy: Linden Gledhill

## Ballistics

With available 13 GPx/s throughput, the 5 Series provides industry-leading resolution values at high frame rates.

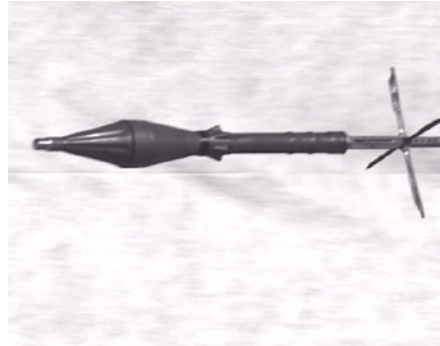

## Digital Image Correlation (DIC)

The 5 Series features a very low noise floor, enabling DIC displacement measurements even at high frequencies.



Courtesy: MatchID

## Motion Analysis

The i-SPEED 5's balance between resolution and frame rate produces clear images for accurate 2D and 3D analysis.

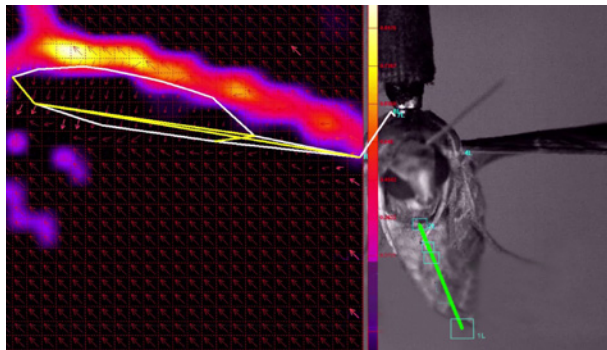

## PIV

High light sensitivity and 13.5µm pixel size provide images ideal for PIV applications.

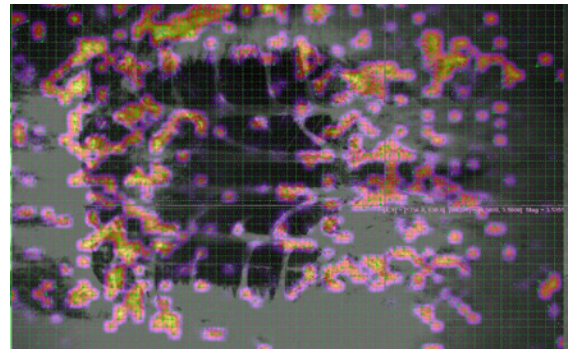

## Scientific Research

Compact size along with a wealth of functions and features make the i-SPEED 5 Series ideal for lab or field research.

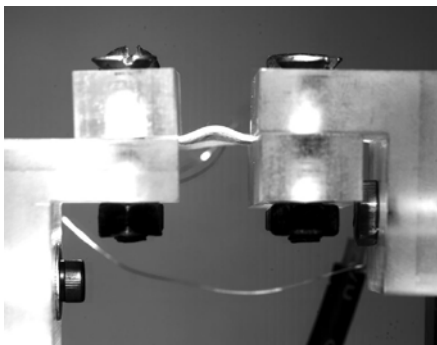

## Fragmentation

The environmentally sealed i-SPEED 5 camera body protects internal electronics and the image sensor.



## Schlieren

Traditional mirror and modern digital techniques both excel with the AST Sensor due to its high sensitivity and resolution.



# A legacy built on innovation

iX Cameras is a world-leading technology and product company specializing in the field of high-speed (slow motion) imaging. Based on proprietary innovative technologies, we design, build and sell cutting-edge, ultra-fast cameras and software for a wide range of advanced scientific research applications. The innovation of our i-SPEED® brand of cameras is backed by our world-class service and support teams, ensuring our customers' success.

iX Cameras was created in 2014 when we purchased the Olympus product group that has been developing and selling the i-SPEED brand of high-speed cameras for over a decade. Today, the same heralded development team from Olympus, combined with new camera and software industry veterans, continues to design innovative state-of-the-art i-SPEED cameras under the iX Cameras brand. Our commitment is simple—innovate and push the boundaries of high-speed video science, developing technically superior and easy-to-use products that allow customers to attain the highest scientific achievements and creativity.



## iX Camera support and service locations

iX Cameras is dedicated to providing the best support and customer communication possible. Use the information below to get comprehensive company-wide contact information for any question or topic which you may have.

### United Kingdom

Bradley House  
Locks Hill  
Rochford Essex, SS4 1BB  
T: +44 (0) 1702 540 669

### United States

8 Cabot Road  
Suite 1800  
Woburn, MA 01801  
T: +1 339 645 0778

### China

Room 605, Building 8  
No 365, Chuanhong Road  
Pudong New District  
Shanghai, 201323  
T: +86 186 215 60553

### India

C-207, Twin Arcs  
Legacy Life Spaces, Punwale Bazar  
Punawale, Pune-411033  
Maharashtra  
T: +91 955 256 5021

[info@ix-cameras.com](mailto:info@ix-cameras.com)

[ix-cameras.com](http://ix-cameras.com)

To find the iX Cameras sales partner nearest you, visit our [Worldwide Distribution](#) page.